

# いぬ



難しさ



(1) パーツを切り取り、点線に沿って折る  
胴体は○部分にのりをつけて接着させておく

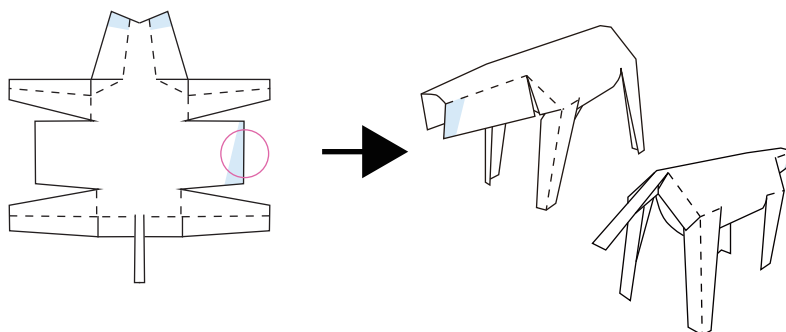

(2) 頭に耳をつける

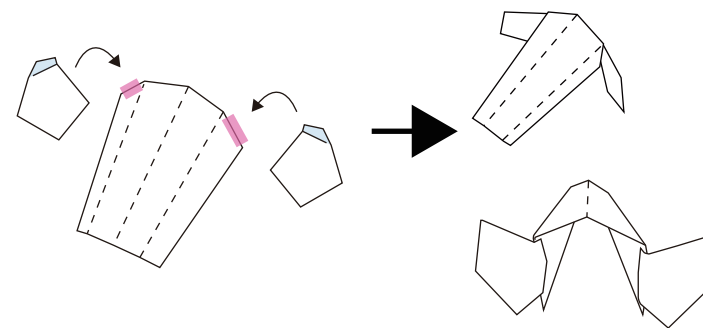

(3) 頭部と胴体を合体させる

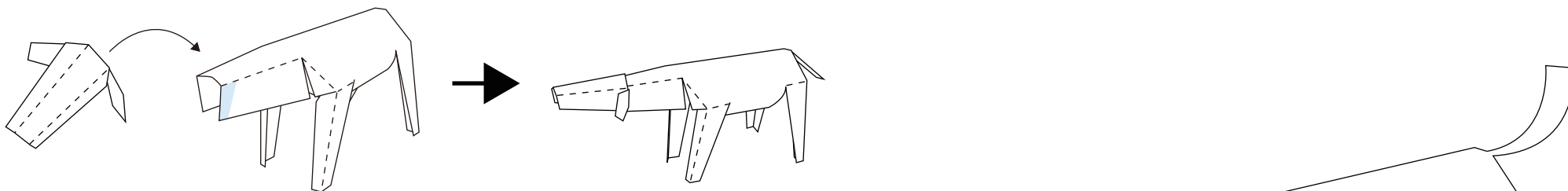

完成!

(4) 首と尻尾を軽く曲げる

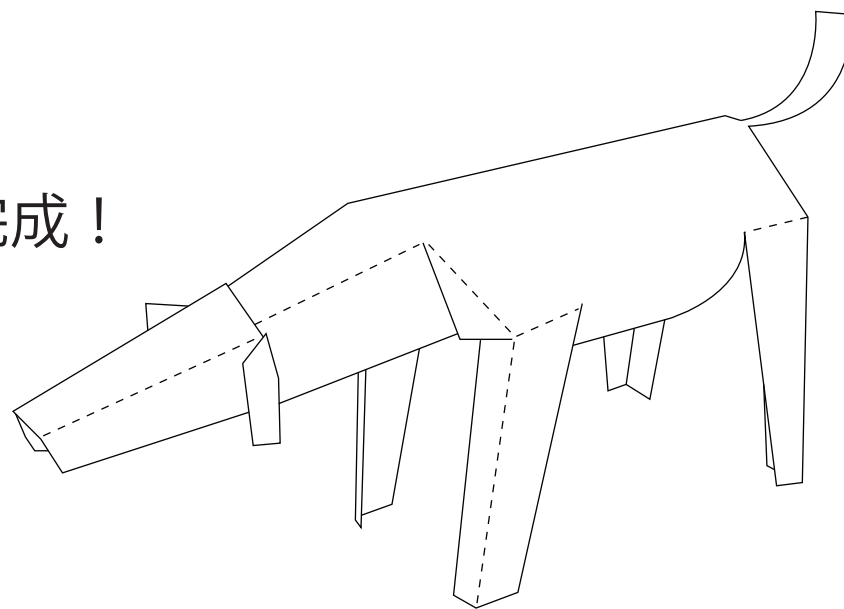
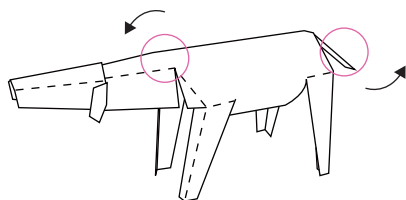

# ぞう



難しさ



(1) パーツを切り取り、点線に沿って折る  
胴体は○部分にのりをつけて接着させておく

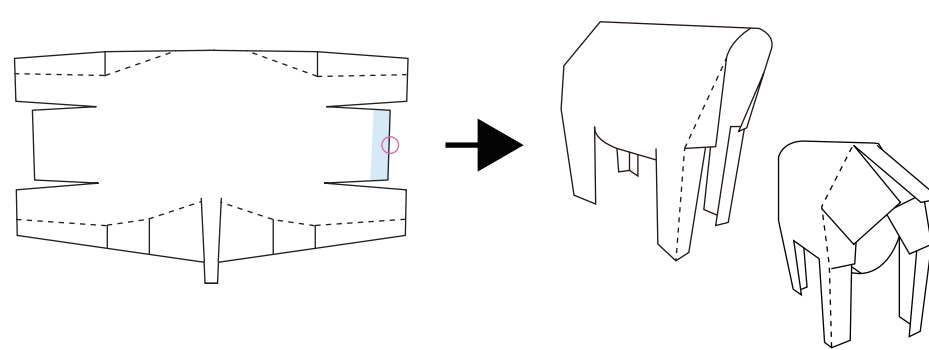

(2) 頭ののりしろ部分にのりをつけ、  
矢印の方向に差し込んで貼る

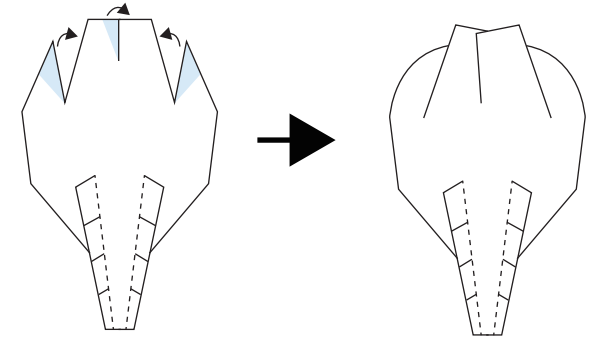

(3) 頭に耳をつけ、鼻は軽く曲げる

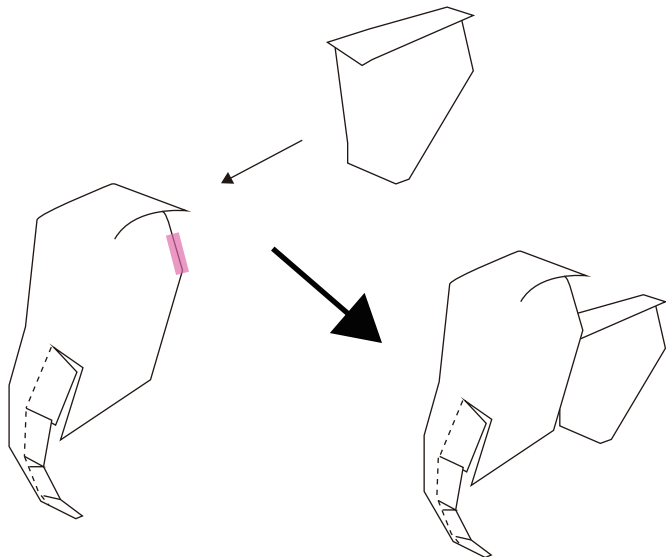

(4) 胴体に頭をつける

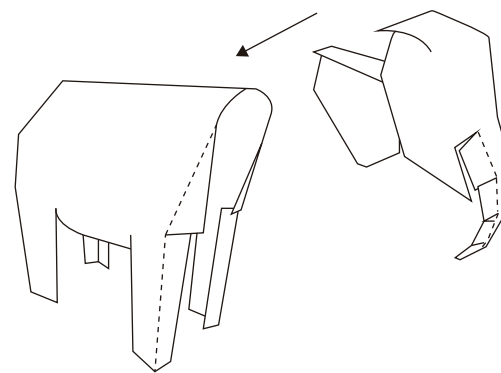

完成！

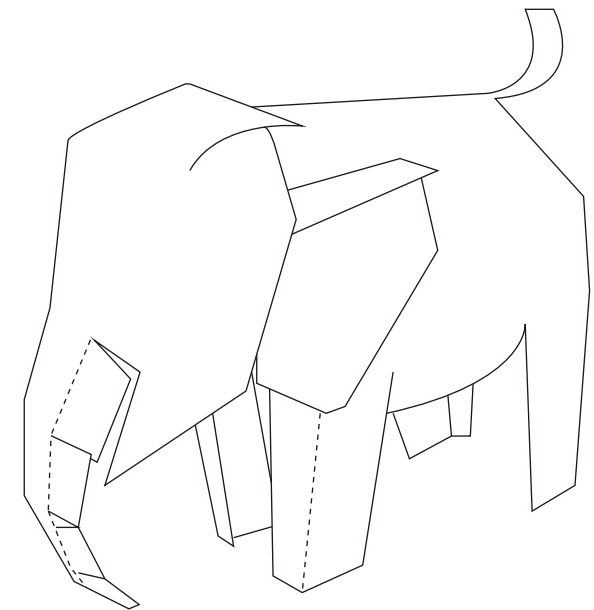

# きりん



難しさ



- (1) パーツを切り取り、点線に沿って折る  
角は先端を軽く丸め、胴体は○部分にのりをつけて接着させておく

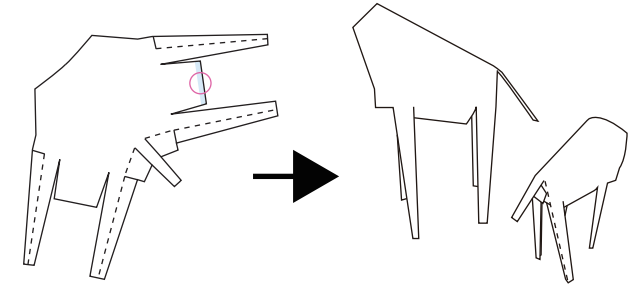
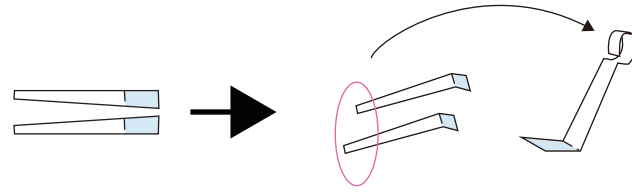

- (2) 頭に角と耳をつける

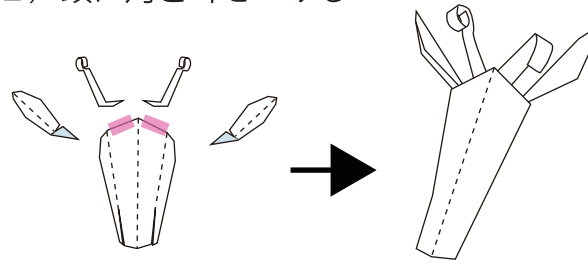

- (3) 背中側と腹側の首を張り合わせ、胸と一緒に胴体につける

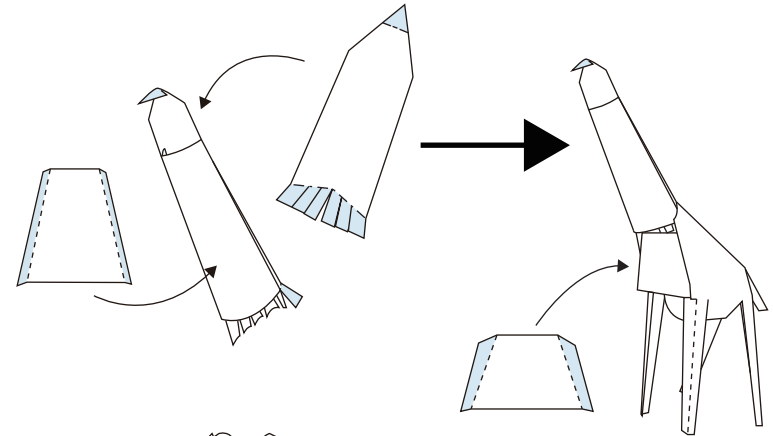

- (4) 頭を首につける

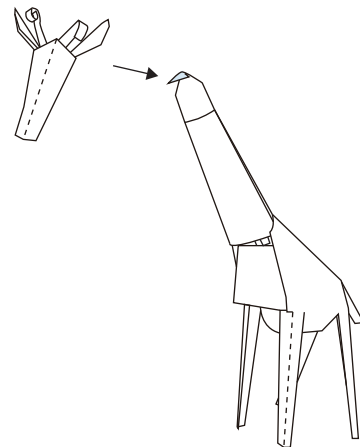

完成！

